

BOTÃO DE IMPULSO

GBI

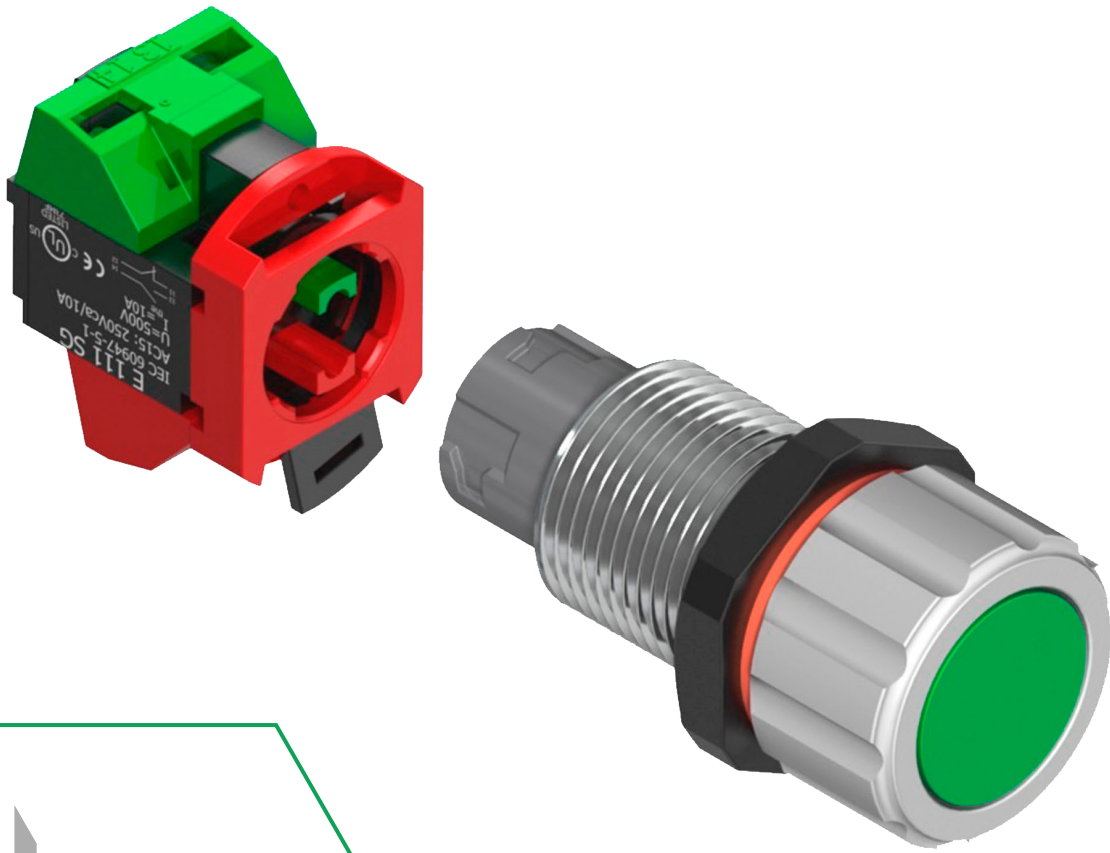





sermat **GRÜN**
ex

REV.23 / 06.03.2025

BOTÃO DE IMPULSO

Informações Técnicas

ESPECIFICAÇÕES TÉCNICAS

TIPO DE PROTEÇÃO	Ex "d" – à prova de explosão Ex "t" – contra ignição poeira	à prova de explosão contra ignição poeira	Ex "d" – à prova de explosão Ex "t" – contra ignição poeira
MARCAÇÃO	Ex db IIC Gb Ex tb IIIC Db	Class I, Groups B, C, D Class II, Groups E, F, G Class III	II 2 G Ex db IIC / IIB +H ₂ Gb II 2 D Ex tb IIIC Db
ÁREA DE APLICAÇÃO	Zona 1 Zona 2 Zona 21 Zona 22	Class I, Div 1 & 2, Groups B, C, D. Class II, Div 1 & 2, Groups E, F, G. Class III	Zona 1 Zona 2 Zona 21 Zona 22
GRAU DE PROTEÇÃO	IP66W (W: névoa salina)	Type 4X	IP66
TEMPERATURA DE APLICAÇÃO	-50°C à 60°C (-40°F à 158°F)	-50°C à 60°C (-40°F à 158°F)	-50°C à 100°C (-40°F à 212°F)
ROSCA	M22 x 1,5 3/4" NPSM	M22 x 1,5 3/4" NPSM	M22 x 1,5 3/4" NPSM
COMPRIMENTO DE ROSCA	25mm (Normal) 40mm (Longo) 57mm (Extra Longo)	25mm (Normal) 40mm (Longo) 57mm (Extra Longo)	25mm (Normal) 40mm (Longo) 57mm (Extra Longo)
INSTALAÇÃO	para rosca M22x1,5 Invólucros Ex "d": (min. espes- sura de parede: 8 mm de rosca acoplada). Invólucros Ex "tb": (min. espes- sura de parede: 3 mm de rosca acoplada).	para rosca M22x1,5 Invólucros Ex "d": (min. 6 filetes de rosca totalmente acoplados). Invólucros Ex "tb": (min. 3 filetes de rosca totalmente acoplados).	para rosca M22x1,5 Invólucros Ex "d": (min. espes- sura de parede: 8 mm de rosca acoplada). Invólucros Ex "tb": (min. espes- sura de parede: 3 mm de rosca acoplada).
	para rosca 3/4"NPSM Invólucros Ex "d": (min. 5 filetes de rosca totalmente acoplados). Invólucros Ex "tb": (min. espes- sura de parede: 3,7 mm de rosca acoplada).	para rosca 3/4"NPSM Invólucros Ex "d": (min. 7 filetes de rosca totalmente acoplados). Invólucros Ex "tb": (min. 3 filetes de rosca totalmente acoplados).	para rosca 3/4"NPSM Invólucros Ex "d": (min. 5 filetes de rosca totalmente acoplados). Invólucros Ex "tb": (min. espes- sura de parede: 3,7 mm de rosca acoplada).
CERTIFICADO DE CONFORMIDADE	Segurança  OCP 0034  INMETRO	 UL LISTED	  ATEX I IECEx
	INMETRO NCC 24.0128 U	UL FILE: E489210	ATEX I IECEx UL 21 ATEX 2390U IECEx ULBR 21.0004U

BOTÃO DE IMPULSO

Informações Técnicas

INFORMAÇÕES ELÉTRICAS

DADOS DOS BLOCOS DE CONTATO		
TENSÃO NOMINAL	Ui 500V	
CORRENTE NOMINAL	Ith 10A	
CONTATOS PARA AC 15	TENSÃO	CORRENTE
	220V	10A
	380V	7,5A
CONTATOS PARA DC 13	500V	5A
	TENSÃO	CORRENTE
	24V	2,75A
	60V	1,10A
110V	0,55A	
220V	0,27A	

DIMENSÕES

X	
mm	polegadas
25mm	≈ 1"
40mm	≈ 1.19/32"
57mm	≈ 2.1/4"

M22 X 1,5

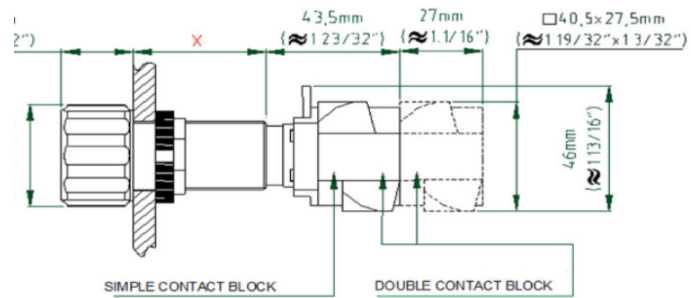

3/4"NPSM

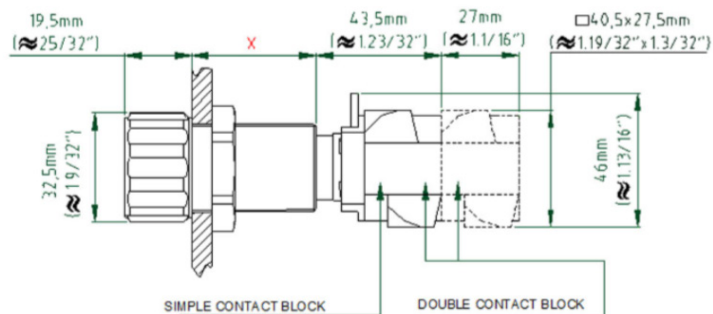

BOTÃO DE IMPULSO

Sistema de Codificação

SISTEMA DE CODIFICAÇÃO

SGEXXGBI A + B + C

X

TAMANHO DA ROSCA

tamanho	M22x1,5	3/4"NPSM
código	22	26

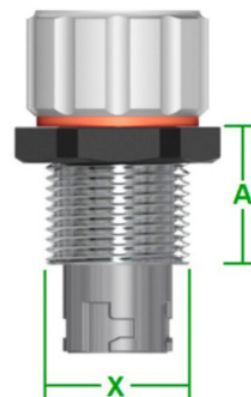

A

COMPRIMENTO DA ROSCA

compr.	25mm	40mm	57mm
código	N	L	X

B

COR



cor	Azul	Amarelo	Vermelho	Verde	Branco	Preto
código	AZ	AM	VM	VD	BR	PR

C

BLOCOS DE CONTATO



	NA	NF	NANF	2NA	2NF
código	10	01	11	20	02

BLOCOS DE CONTATO ESPECIAIS

BLOCOS DE CONTATO DUPLOS



	1NA3NF	4NF	4NA	3NA1NF	2NA2NF
código	13	04	40	31	22

BLOCOS DE CONTATO COM RETENÇÃO

FUNÇÃO:
EMPURRA-LIGA,
EMPURRA-DESLIGA







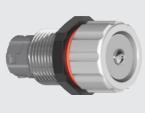

	NA (c/ retenção)	NF (c/ retenção)	NANF (c/ retenção)	2NA (c/ retenção)	2NF (c/ retenção)
código	10R	01R	11R	20R	02R

BOTÃO DE IMPULSO

Exemplos de Codificação & Acessórios

EXEMPLOS DE CODIFICAÇÃO

	+	3/4"NPSM COMPR. 25MM	+		+		=	SGEX26GBINVM01
SGEX26GBI		N		VM		01		
	+	M22X1,5 COMPR. 25MM	+		+		=	SGEX22GBINVD10
SGEX22GBI		N		VD		10		

ACESSÓRIOS

PLAQUETA DE IDENTIFICAÇÃO (apenas para M22x1,5)

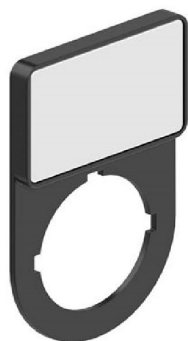

CÓDIGO	S2PL1		
ÁREA P/ INSCRIÇÃO	19x27 mm		
G00	LIGA	G05	STOP
G01	DESLIGA	G06	RESET
G02	ABRE	G07	OPEN
G03	FECHA	G08	CLOSE
G04	START	G09	

DIMENSÕES (mm)

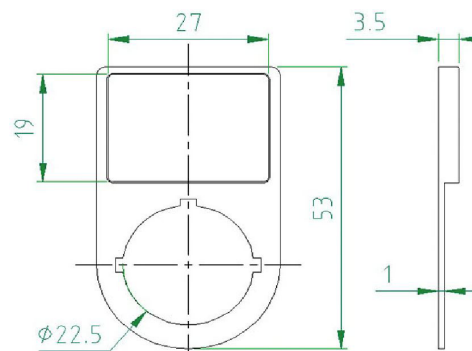

ELEMENTO TRAVA C/ ACIONAMENTO MANTIDO (3/4"NPSM ou M22x1,5)



CÓDIGO E-TRAVA-CM

O E-TRAVA-CM mantém o botão travado com acionamento mantido.



DIMENSÕES (mm)

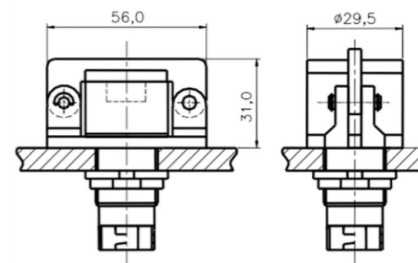

ELEMENTO TRAVA S/ ACIONAMENTO MANTIDO (3/4"NPSM ou M22x1,5)



CÓDIGO E-TRAVA-SM

O E-TRAVA-SM impede o botão de ser pressionado.



DIMENSÕES (mm)

