

MUSHROOM-HEAD PUSH-BUTTON WITH KEY

GBEY

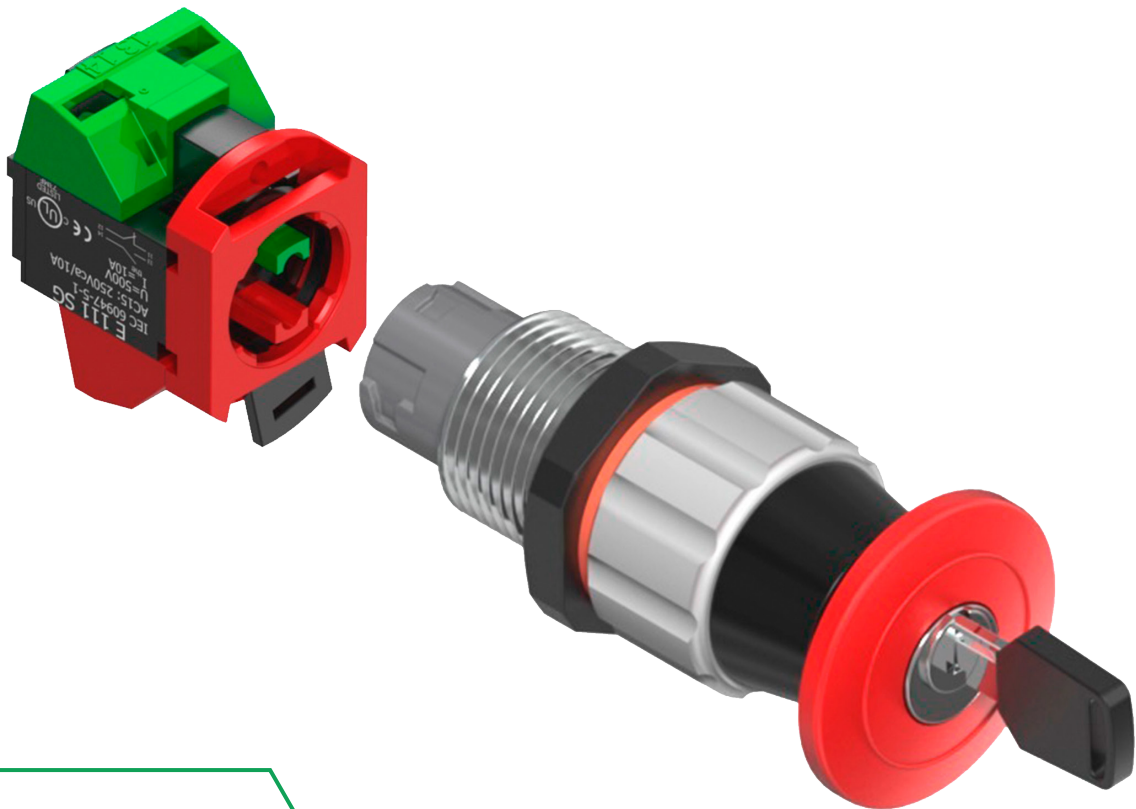

sermat **GRÜN**
ex





REV.23 / 06.03.2025

MUSHROOM-HEAD PUSH-BUTTON WITH KEY

Technical Data



TECHNICAL SPECIFICATION

TYPE OF PROTECTION	Ex "d" – Flameproof Ex "t" – Dust ignition protection	Explosion proof Dust ignition proof	Ex "d" – Flameproof Ex "t" – Dust ignition protection
MARKING	Ex db IIC Gb Ex tb IIIC Db	Class I, Groups B, C, D Class II, Groups E, F, G Class III	II 2 G Ex db IIC / IIB +H ₂ Gb II 2 D Ex tb IIIC Db
AREA OF APPLICATION	Zone 1 Zone 2 Zone 21 Zone 22	Class I, Div 1 & 2, Groups B, C, D. Class II, Div 1 & 2, Groups E, F, G. Class III	Zone 1 Zone 2 Zone 21 Zone 22
INGRESS PROTECTION	IP66W (W: salt spray)	Type 4X	IP66
TEMPERATURE RANGE	-50°C to 60°C (-40°F to 158°F)	-50°C to 60°C (-40°F to 158°F)	-50°C to 100°C (-40°F to 212°F)
THREAD SIZE	M22 x 1,5 3/4" NPSM	M22 x 1,5 3/4" NPSM	M22 x 1,5 3/4" NPSM
THREAD LENGTH	25mm (Normal) 40mm (Long) 57mm (Extra Long)	25mm (Normal) 40mm (Long) 57mm (Extra Long)	25mm (Normal) 40mm (Long) 57mm (Extra Long)
INSTALLATION	for M22x1,5 THREAD in Ex "d" enclosures : (min. wall thickness : 8 mm engaged thread) in Ex "tb" enclosures : (min. wall thickness : 3 mm engaged thread)	for M22x1,5 THREAD in Ex "d" enclosures : (min. 6 fully engaged threads) in Ex "tb" enclosures : (min. 3 fully engaged threads)	for M22x1,5 THREAD in Ex "d" enclosures : (min. wall thickness : 8 mm engaged thread) in Ex "tb" enclosures : (min. wall thickness : 3 mm engaged thread)t
	for 3/4"NPSM THREAD in Ex "d" enclosures : (min. 5 fully engaged threads) in Ex "tb" enclosures : (min. wall thickness : 3,7 mm engaged thread)	for 3/4"NPSM THREAD in Ex "d" enclosures : (min. 7 fully engaged threads) in Ex "tb" enclosures : (min. 3 fully engaged threads)	for 3/4"NPSM THREAD in Ex "d" enclosures : (min. 5 fully engaged threads) in Ex "tb" enclosures : (min. wall thickness : 3,7 mm engaged thread)
CERTIFICATE OF COMPLIANCE	<p>Segurança</p>   <p>OCP 0034 INMETRO</p>	 <p>UL LISTED</p>	  <p>ATEX I IECEx</p>
	INMETRO NCC 24.0128 U	UL UL: E489210	ATEX I IECEx UL 21 ATEX 2390U IECEx ULBR 21.0004U

MUSHROOM-HEAD PUSH-BUTTON WITH KEY

Technical Data

ELECTRICAL INFORMATION

CONTACT BLOCKS INFORMATION		
RATED VOLTAGE	Ui 500V	
RATED CURRENT	Ith 10A	
CONTACTS FOR AC 15	VOLTAGE	CURRENT
	220V	10A
	380V	7,5A
CONTACTS FOR DC 13	VOLTAGE	CURRENT
	24V	2,75A
	60V	1,10A
	110V	0,55A
	220V	0,27A

DIMENSIONS

X	
mm	inch
25mm	≈ 1"
40mm	≈ 1.19/32"
57mm	≈ 2.1/4"

M22 X 1,5

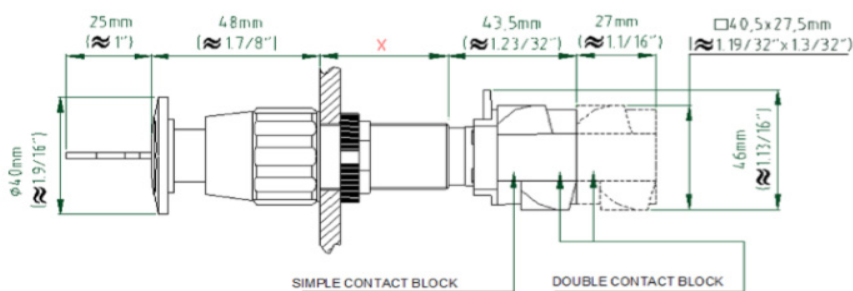

3/4"NPSM

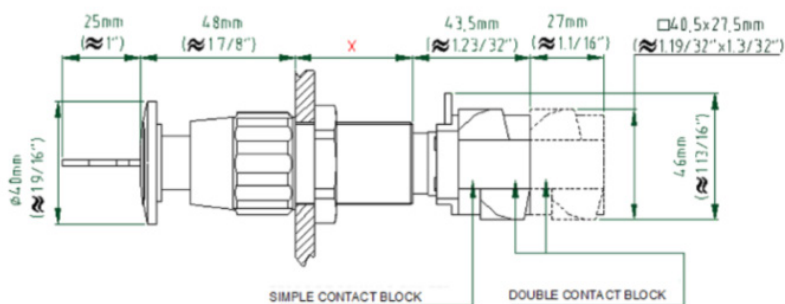

MUSHROOM-HEAD PUSH-BUTTON WITH KEY

Ordering Code &
Codification Exemples

ORDERING CODE

SGEXXGBEY A + B

X

THREAD SIZE

size	M22x1,5	3/4"NPSM
code	22	26

A

THREAD LENGTH

length	25mm	40mm	57mm
code	N	L	X



B

CONTACT BLOCKS

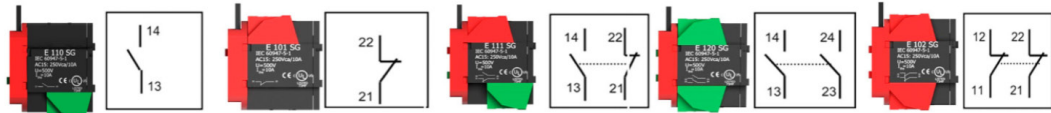

	NO	NC	NONC	2NO	2NC
code	10	01	11	20	02



SPECIAL CONTACT BLOCK



DOUBLE CONTACT BLOCKS



	1NO3NC	4NC	2NO1NC	1NO2NC	4NO	3NO1NC	2NO2NC
code	13	04	21	12	40	31	22

CODIFICATION EXAMPLES

	+	3/4NPSM LENGTH 25MM	+		=	SGEX26GBEYN01
SGEX26GBEY		N		01		

	+	M22X1,5 LENGTH 25MM	+		=	SGEX22GBEYN10
SGEX22GBEY		N		10		

MUSHROOM-HEAD PUSH-BUTTON WITH KEY

Accessories

ACCESSORIES

IDENTIFICATION PLATE (only for M22x1,5 thread)

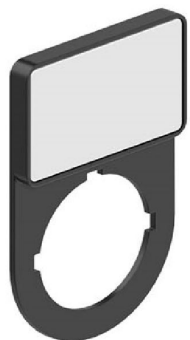

CODE	S2PL1
------	-------

PRINTABLE AREA	19x27 mm
----------------	----------

G00	LIGA	G05	STOP
G01	DESLIGA	G06	RESET
G02	ABRE	G07	OPEN
G03	FECHA	G08	CLOSE
G04	START	G09	

DIMENSIONS (mm)

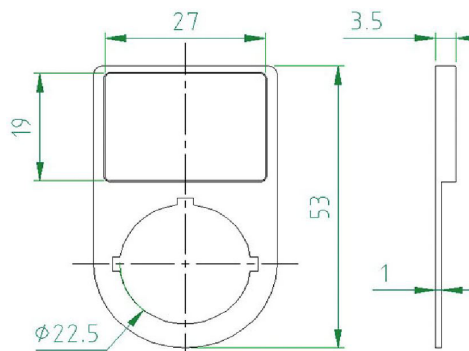

BACK PLATE (for 3/4 NPSM or M22x1,5 thread)



CODE	S2PE
------	------

DIMENSIONS (mm)

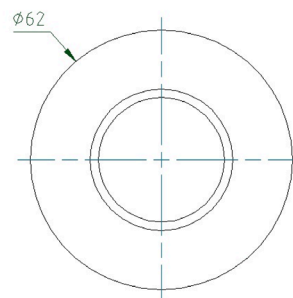

sermat **GRÜN**
ex